

AT8PSN / AT8PMN Series Power OFF Delay Timer

DIN W48 × H48mm Solid-state, Power OFF Delay timer

■ Features

- Time setting range
(AT8PSN : 0.05 to 10sec., AT8PMN : 0.05 to 10min.)
- Simple time setup and direct read of time range
- Power supply
: 100-120VAC 50/60Hz, 200-240VAC 50/60Hz
100/110VDC, 24VAC 50/60Hz / 24VDC universal
- Application : Protect circuit when momentary power failure and start it again



⚠ Please read "Caution for your safety" in operation manual before using.



■ Ordering information

AT 8 P SN - □

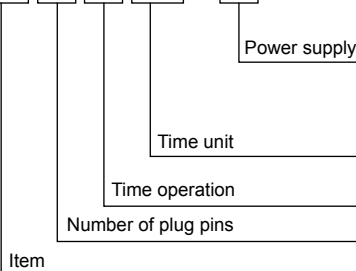

| | |
|---------|-----------------|
| No mark | 200-240VAC |
| 2 | 24VAC/DC |
| 6 | 100-120VAC |
| 7 | 100/110VDC |
| SN | sec |
| MN | min |
| P | Power OFF Delay |
| 8 | 8-pin plug type |
| AT | Analog Timer |

■ Specifications

※Sockets (PG-08, PS-08) are sold separately.

| Model | ATS8PSN-□ | ATS8PMN-□ |
|----------------------------|--|---|
| Function | Power OFF Delay | |
| Control time setting range | 0.05 to 10 sec. | 0.05 to 10 min. |
| Power supply | • 100-120VAC 50/60Hz • 200-240VAC 50/60Hz • 100/110VDC • 24VAC 50/60Hz, 24VDC (universal) | |
| Allowable voltage range | 90 to 110% of rated voltage | |
| Power consumption | • 100-120VAC : 1.5VA • 200-240VAC : 1.5VA • 100/110VDC : 0.8W • 24VDC : 0.2VA, 24VDC 0.2W | |
| Timing operation | Power OFF start type | |
| Control output | Contact type | Time limit DPDT(2c) |
| | Contact capacity | 250VAC 3A resistive load |
| Relay life cycle | Mechanical | Min.10,000,000 operations |
| | Electrical | Min. 100,000 operations(250VAC 3A resistive load) |
| Repeat error | Max. ±0.2 % ±10ms | |
| Setting error | Max. ±5% ±50ms | |
| Voltage error | Max. ±0.5% | |
| Temperature error | Max. ±2% | |
| Insulation resistance | 100MΩ(at 500VDC megger) | |
| Dielectric strength | 2000VAC 50/60Hz for 1 minute | |
| Noise strength | ±2kV the square wave noise(pulse width : 1μs) by the noise simulator | |
| Vibration | Mechanical | 0.75mm amplitude at frequency of 10 to 55Hz(for 1 min.) in each of X, Y, Z directions for 1 hours |
| | Malfunction | 0.5mm amplitude at frequency of 10 to 55Hz(for 1 min.) in each of X, Y, Z directions for 10 minutes |
| Shock | Mechanical | 300m/s ² (approx. 30G) in each of X, Y, Z directions 3 times |
| | Malfunction | 100m/s ² (approx. 10G) in each of X, Y, Z directions 3 times |
| Environment | Ambient temperature | -10 to 55°C, storage: -25 to 65°C |
| | Ambient humidity | 35 to 85%RH |
| Approval | CE c UL US | |
| Accessory | Bracket | |
| Unit weight | Approx. 100g | |

※Environment resistance is rated at no freezing or condensation.

| | |
|-----|----------------------------------|
| (A) | Photo electric sensor |
| (B) | Fiber optic sensor |
| (C) | Door/Area sensor |
| (D) | Proximity sensor |
| (E) | Pressure sensor |
| (F) | Rotary encoder |
| (G) | Connector/Socket |
| (H) | Temp. controller |
| (I) | SSR/ Power controller |
| (J) | Counter |
| (K) | Timer |
| (L) | Panel meter |
| (M) | Tacho/ Speed/ Pulse meter |
| (N) | Display unit |
| (O) | Sensor controller |
| (P) | Switching mode power supply |
| (Q) | Stepper motor& Driver&Controller |
| (R) | Graphic/ Logic panel |
| (S) | Field network device |
| (T) | Software |
| (U) | Other |

AT8PSN / AT8PMN Series

■ Connections

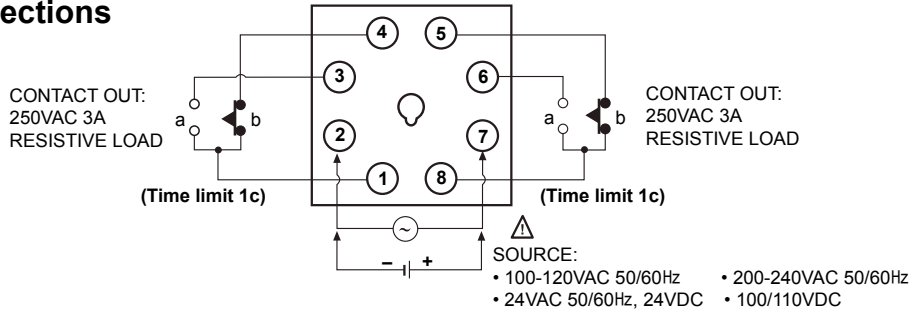

■ Dimensions

(unit: mm)

● Bracket

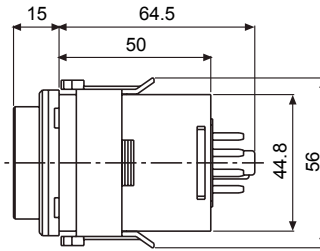
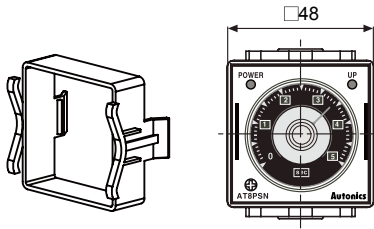

● Panel cut-out

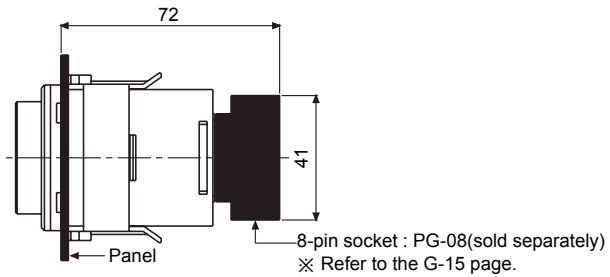
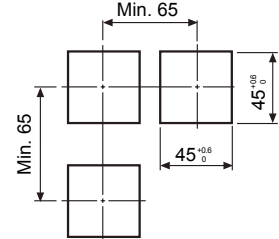

■ Parts description

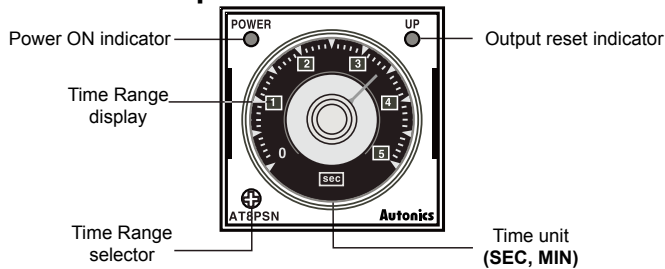

● Time specification

| | Unit | |
|-------------------------------|-------------------|-------------------|
| | SEC (AT8PSN-□) | MIN (AT8PMN-□) |
| Setting time range(T) | 0 to 0.5 sec | 0 to 0.5 min |
| | 0 to 1.0 sec | 0 to 1.0 min |
| | 0 to 5 sec | 0 to 5 min |
| | 0 to 10 sec | 0 to 10 min |
| Min. time to supply the power | 0.1sec. | 2sec. |

■ Output operation mode

Contact turns ON when the power applied and then turns off after setting time(T) is passed when the power off. There is memory protection function. Even though changing setting time after cutting the power, time limit a contact turns OFF after the setting time before cutting the power.

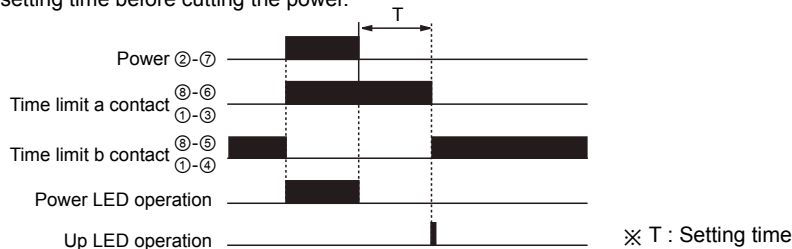

■ Proper usage

- Power
- This product is power OFF delay timer, the time of min. power supply is 0.1sec. for AT8PSN-□ type and 2sec. for AT8PMN-□. Therefore be sure that this product will operation after power off.
- Please observe the allowable voltage range and apply or cut the power at once to prevent from chattering.

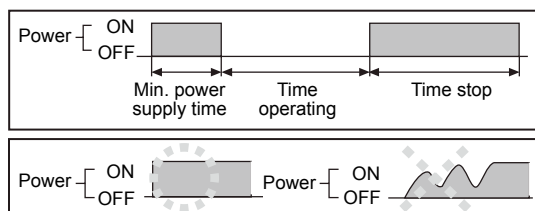

※ Please use the power within rating power and apply.

- In case of 24VDC/DC, 100/110VDC model, isolated and limited voltage/current or Class 2 source should be provided for power supply.
- When supplying the power to the timer with 100-120VAC or 200-240VAC, approx. 0.5A will flow for 0.5 sec. (AT8PMN-□), or for 0.05 sec. (AT8PSN-□). When supplying the power to the timer with 24VDC, 100/110VDC approx. 1.5A will flow for 0.5 sec. (AT8PMN-□), or for 0.05 sec.(AT8PSN-□). Therefore be sure about the rating of contact and the power capacity.
- When performing dielectric voltage test or insulation resistance test while the unit is installed on control panel,
 - Please isolate this unit from the circuit of control panel.
 - Please make all terminals of this unit short-circuited.
- Do not use this unit at below places.
 - Place where there are severe vibration or impact.
 - Place where strong alkalis or acids are used.
 - Place where there are direct rays of the sun
 - Place where strong magnetic field or electric noise are generated.
- Installation environment
 - It shall be used indoor
 - Altitude Max. 2000m
 - Pollution Degree 2
 - Installation Category II

| | |
|-----|----------------------------------|
| (A) | Photo electric sensor |
| (B) | Fiber optic sensor |
| (C) | Door/Area sensor |
| (D) | Proximity sensor |
| (E) | Pressure sensor |
| (F) | Rotary encoder |
| (G) | Connector/Socket |
| (H) | Temp. controller |
| (I) | SSR/ Power controller |
| (J) | Counter |
| (K) | Timer |
| (L) | Panel meter |
| (M) | Tacho/ Speed/ Pulse meter |
| (N) | Display unit |
| (O) | Sensor controller |
| (P) | Switching mode power supply |
| (Q) | Stepper motor& Driver&Controller |
| (R) | Graphic/ Logic panel |
| (S) | Field network device |
| (T) | Software |
| (U) | Other |